



McIntosh Laboratory, Inc. 2 Chambers Street Binghamton, New York 13903-2699 Phone: 607-723-3512 www.mcintoshlabs.com

MB100

Media Bridge

Owner's Manual



The lightning flash with arrowhead, within an equilateral triangle, is intended to alert the user to the presence of uninsulated “dangerous voltage” within the product’s enclosure that may be of sufficient magnitude to constitute a risk of electric shock to persons.

WARNING - TO REDUCE RISK OF FIRE OR ELECTRICAL SHOCK, DO NOT EXPOSE THIS EQUIPMENT TO RAIN OR MOISTURE.



AVIS RISQUE DE CHOC ELECTRIQUE - NE PAS OUVRIR.

NO USER-SERVICEABLE PARTS INSIDE. REFER SERVICING TO QUALIFIED PERSONNEL.

The exclamation point within an equilateral triangle is intended to alert the user to the presence of important operating and maintenance (servicing) instructions in the literature accompanying the appliance.

To prevent the risk of electric shock, do not remove cover or back. No user-serviceable parts inside.

IMPORTANT SAFETY INSTRUCTIONS!

PLEASE READ THEM BEFORE OPERATING THIS EQUIPMENT.

1. Read these instructions.
2. Keep these instructions.
3. Heed all warnings.
4. Follow all instructions.
5. Do not use this apparatus near water.
6. Clean only with a dry cloth.
7. Do not block any ventilation openings. Install in accordance with the manufacturer’s instructions.
8. Do not install near any heat sources such as radiators, heat registers, stoves, or other apparatus (including amplifiers) that produce heat.
9. Do not defeat the safety purpose of the polarized or grounding-type plug. A polarized plug has two blades with one wider than the other. A grounding type plug has two blades and a third grounding prong. The wide blade or the third prong are provided for your safety. If the pro-

vided plug does not fit into your outlet, consult an electrician for replacement of the obsolete outlet.

10. Protect the power cord from being walked on or pinched particularly at plugs, convenience receptacles, and the point where they exit from the apparatus.
11. Only use attachments/accessories specified by the manufacturer.
12. Use only with the cart, stand, tripod, bracket, or table specified by the manufacturer, or sold with the apparatus. When a cart is used, use caution when moving the cart/apparatus combination to avoid injury from tip-over.
13. Unplug this apparatus during lightning storms or when unused for long periods of time.
14. Refer all servicing to qualified service personnel. Servicing is required when the apparatus has been damaged in any way, such as power-supply cord or plug is damaged, liquid has been spilled or objects have fallen into the apparatus, the apparatus has been exposed to rain or



moisture, does not operate normally, or has been dropped.

15. Do not expose this equipment to dripping or splashing and ensure that no objects filled with liquids, such as vases, are placed on the equipment.
16. To completely disconnect this equipment from the a.c. mains, disconnect the AC / DC Adapter from the a.c. receptacle.
17. The mains plug of the power supply cord shall remain readily operable. If the AC /DC Adapter is provided with a mains power supply cord attachment, the plug of this power supply cord shall remain readily operable.
18. Do not expose batteries to excessive heat such as sunshine, fire or the like.
19. Connect mains power supply cord only to a mains socket outlet with a protective earthing connection.
20. **Warning: The Ethernet connector of this equipment must not be directly connected to a public network. Connection is to be made only by way of a modem or router approved for this purpose.**

Thank You

Your decision to own this McIntosh MB100 Media Bridge ranks you at the very top among discriminating music listeners. You now have the best. The McIntosh dedication to precision performance assures many years of musical enjoyment.

Please take a short time to read the information in this guide. We want you to be as familiar as possible with all the features and functions of your new McIntosh.

Please Take A Moment

The serial number, purchase date and McIntosh Dealer name are important to you for possible insurance claim or future service. The spaces below have been provided for you to record that information:

Serial Number: _____

Purchase Date: _____

Dealer Name: _____

Technical Assistance

If at any time you have questions about your McIntosh product, contact your McIntosh Dealer who is familiar with your McIntosh equipment and any other brands that may be part of your system. If you or your Dealer wish additional help concerning a suspected problem, you can receive technical assistance for all McIntosh products at:

McIntosh Laboratory, Inc.
2 Chambers Street
Binghamton, New York 13903
Phone: 607-723-3512
Fax: 607-724-0549

Customer Service

If it is determined that your McIntosh product is in need of repair, you can return it to your Dealer. You can also return it to the McIntosh Laboratory Service Department. For assistance on factory repair return procedure, contact the McIntosh Service Department at:

McIntosh Laboratory, Inc.
2 Chambers Street
Binghamton, New York 13903
Phone: 607-723-3515
Fax: 607-723-1917

Table of Contents

Safety Instructions.....	2
Thank You and Please Take a Moment	3
Technical Assistance and Customer Service.....	3
Table of Contents	3
General Information	4
Connector and Cable Information	4
Introduction	5
Performance Features	5
Dimensions	6
Installation	7
Rear Panel Connections.....	8
AC/DC Adapter	9
MB100 Connections	10-11
Front Panel Display and Push-button	12
How to use the Remote Control.....	13
How to Operate the Setup Mode	14-15
How to Operate the MB100.....	16-20
Specifications.....	22
Packing Instructions	23

Trademark and License Information

The McIntosh MB100 incorporates copyright protection technology that is protected by U.S. patents and other intellectual property rights.



General Information

1. For additional connection information, refer to the owner's manual(s) for any component(s) connected to the MB100 Media Bridge.
2. When the MB100 Media Bridge is connected to an audio system, playback of music already stored on it may be listened to. To take full advantage of the many features the MB100 is capable of, such as importing and storing additional music on the Media Bridge, requires connection to a Computer Network System.
3. For best performance, the speed of the Computer Network the MB100 Media Bridge would be connected to should be 1 Gigabit or faster.
4. The MB100 internal Digital to Analog Converter Circuitry is designed to decode 2-channel PCM (Pulse Code Modulation) Digital Signals. The Digital Output Signal present at the Coaxial and Optical Output Connectors is a 2-channel PCM (Pulse Code Modulation).
5. The MB100 is designed to be compatible with the majority of Audio Power Amplifiers. However, do to a wide range of Power Amplifier Designs, it is important the input sensitivity of the amplifier be at least 2 Volts. This will assure the playback of most music recordings are reproduced with adequate dynamic range. Check with your McIntosh Dealer for additional information.
6. The IR Input, with a 3.5mm mini phone jack, is configured for non-McIntosh IR sensors such as a Xantech Model HL85BK Kit. Use a Connection Block, such as a Xantech Model ZC21, when two or more IR sensors need to be connected to the MB100.
7. When discarding the unit, comply with local rules or regulations. Batteries should never be thrown away or incinerated but disposed of in accordance with the local regulations 

concerning battery disposal.

8. If it should become necessary to replace the supplied AC / DC Power Adapter, order part number 32056300 from the McIntosh Parts Department.

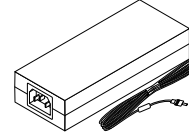

9. For additional information on other McIntosh Products and the downloadable MB100 "Advanced Setup and Operation Guide" please visit the McIntosh Web Site at www.mcintoshlabs.com.
10. Mobile Device Apps, for remote control operation of the MB100, were not available at the time this Owner's Manual was printed. When the Apps become available, an announcement will be made on the McIntosh Web Site at www.mcintoshlabs.com/us/Products/pages/ProductDetails.aspx?CategoryId=mediastreamers&ProductId=MB100. Please note, for remote operation via mobile devices the MB100 needs to be connected to home network with wi-fi capabilities.

Connector and Cable Information

XLR Connectors

Below is the Pin configuration for the XLR Balanced Output Connectors on the MB100. Refer to the diagram for connection:

- PIN 1: Shield/Ground
- PIN 2: + Output
- PIN 3: - Output

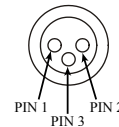

Data and IR Input Port Connectors

The MB100 Data In Port receives Remote Control Signals. A 3.5mm stereo mini phone plug is used for connection. The IR Ports also use a 3.5mm stereo mini

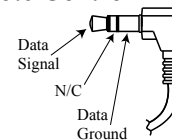

phone plug and allow the connection of other brand IR Receivers to the MB100.

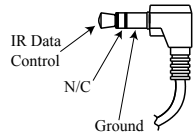

Power Control Connector

The Power Control Input Jack receives Power On/Off Signals (+12 volt/0 volt) when connected to other McIntosh Components. The Power Control Output Jack sends Power On/Off Signals (+12 volt/0 volt) when connected to other McIntosh Components. An additional connection is for controlling the illumination of the Power Output Meters on McIntosh Power Amplifiers. A 3.5mm stereo mini phone plug is used for connection to the Power Control Jacks.

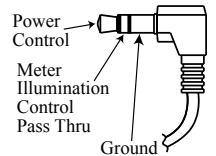

Ethernet RJ45 Socket

1. Tranceive Data (+) 5. N/C
2. Tranceive Data (-) 6. Receive Data (-)
3. Receive Data (+) 7. N/C
4. N/C 8. N/C

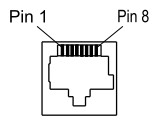

Ethernet Cable - Straight Thru Connections

Pin Number - Wire Color	Pin Number - Wire Color
1. Orange/White →	1. Orange/White
2. Orange →	2. Orange
3. Green/White →	3. Green/White
4. Blue →	4. Blue
5. Blue/White →	5. Blue/White
6. Green →	6. Green
7. Brown/White →	7. Brown/White
8. Brown →	8. Brown



Introduction

The McIntosh MB100 Media Bridge offers the latest in audio technology, providing state of the art audio reproduction with the convenience of instant access to your music library. When the MB100 is added to a McIntosh System, the music from this source may be enjoyed in your home. The advanced design ensures many years of smooth trouble free operation.

Performance Features

• Built-in Networking Capability

The MB100 has the ability to connect to an existing network for connecting to other devices also connected to the network, including the Internet (the Cloud).

• High Storage Capacity

The MB100 incorporates a massive 1 Terabyte Hard Drive capable of storing the contents of a large Music Collection.

• Expand the Music Server System

The MB100 can provide seamless access to music contained on other MB100(s) from different physical locations. It can also access music stored on other devices such as Computers and NAS (Network Assisted Storage) Devices connected to the same network as the MB100. This provides for unlimited music storage capacity.

• USB 3 and USB 2 Inputs

Connect external storage devices to the MB100 for increased music storage capacity.

• Graphical User Interface

When connected to a TV/Monitor, the On Screen Display provides information such as Album Name, Artist Name, Song Name, Playing Time and Location for each of the selections. This allows for easy song selection from multiple rooms in your home.

• HD Video Outputs

The MB100 has DVI-I and HDMI Connections for providing High Definition Video Signals of 1080p or 720p resolutions.

• Internet Streaming Services

The MB100 also allows for listening to Internet Radio Stations when connected.

• Local AM/FM Radio Stations

The MB100 also allows for listening to local AM/FM Stations via the Internet.

• Select your Music

Listen to the music you want by creating your own play lists and/or groups of music types.

• Digital Audio Outputs

There is a Coaxial and an Optical Digital Audio Output for connection to other components.

• Balanced and Unbalanced Analog Outputs

The MB100 has both unbalanced outputs and Balanced Outputs which permitting long cable lengths without a loss in sound quality.

• Alphanumeric OLED Display

The display on the MB100 Front Panel provides various information on the operating status and the current music playing.

• On Screen Setup

The On Screen Setup allows for customizing various settings such as audio, video, network and external control to match the components in your system.

• Power Control

The Power Control Input connection provides convenient Turn-On/Off of the MB100 when connected to a McIntosh System with Power Control.

• Remote Control

The Remote Control with illuminated push-buttons, provides control of the MB100 operating functions. A Data Port Connection to a McIntosh A/V Control Center or Preamplifier allows for convenient system operation using one Remote Control. An External IR Sensor Input allows for remote operation when the MB100 is located behind closed doors.

• Illuminated Glass Front Panel

The MB100 has the famous McIntosh Illuminated Glass Front Panel. The Illumination of the Front Panel is accomplished by the combination of custom designed Fiber Optic Light Diffusers and extra long life Light Emitting Diodes (LEDs). This provides even Front Panel Illumination and is designed to ensure the pristine beauty of the MB100 will be retained for many years.



Dimensions

The following dimensions can assist in determining the best location for your MB100.

Front View of the MB100

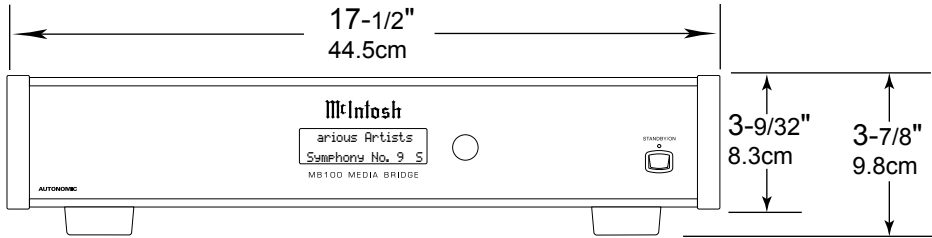

Side View of the MB100

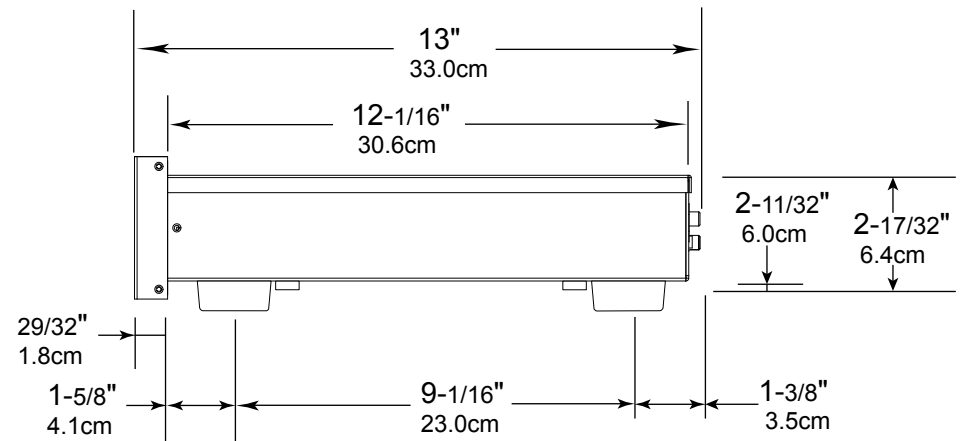

Rear View of the MB100

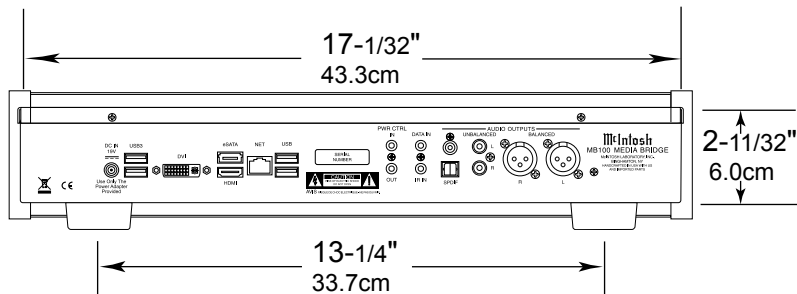

Installation

The MB100 can be placed upright on a table or shelf, standing on its four feet. It also can be custom installed in a piece of furniture or cabinet of your choice. The four feet may be removed from the bottom of the MB100 when it is custom installed as outlined below. The four feet together with the mounting screws should be retained for possible future use if the MB100 is removed from the custom installation and used free standing. The required panel cutout, ventilation cutout and unit dimensions are shown.

Always provide adequate ventilation for your MB100. Cool operation ensures the longest possible operating life for any electronic instrument. Do not install the MB100 directly above a heat generating component such as a high powered amplifier. If all the components are installed in a single cabinet, a quiet running ventilation fan can be a definite asset in maintaining all the system components at the coolest possible operating temperature.

A custom cabinet installation should provide the following minimum spacing dimensions for cool operation.

Allow at least 3 inches (7.6cm) above the top, 2 inches (5.1cm) below the bottom and 1 inch (2.5cm) on each side of the Media Bridge, so that airflow is not obstructed. Allow 17 inches (43.2cm) depth behind the front panel. Allow 29/32 of an inch (1.8cm) in front of the front panel for clearance. **Do not block** the 3-7/8 (9.8cm) inch circular pattern of small openings on the top cover or the two rows of louvers opening on the bottom of the MB100. Be sure to cut out a ventilation hole in the mounting shelf according to the dimensions in the drawing.

**MB100 Front Panel
Custom Cabinet Cutout**

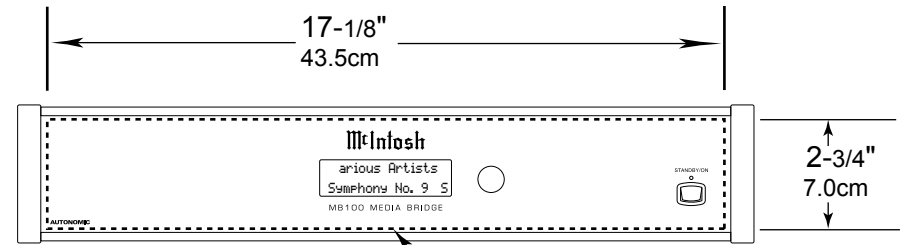

**MB100 Side View
in Custom Cabinet**

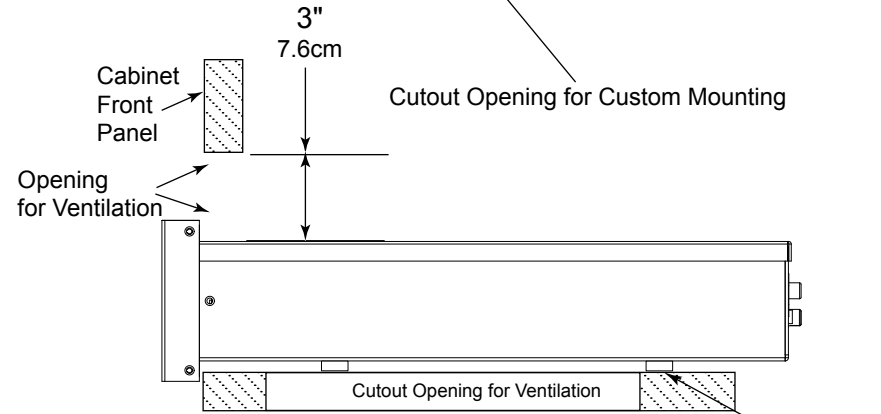

**MB100 Bottom View
in Custom Cabinet**

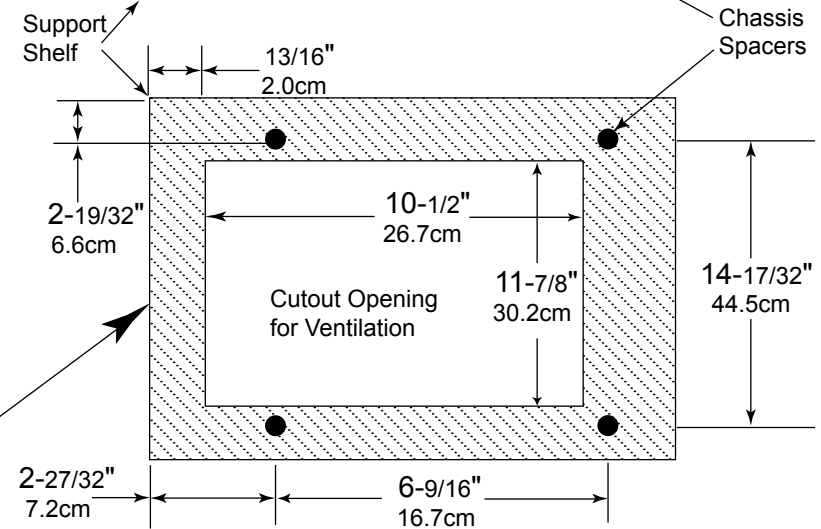

*Note: Center the cutout Horizontally on the unit.
For purposes of clarity, the above
illustration is not drawn to scale.*



Rear Panel Connections

Connect the supplied AC/DC Power Adapter DC Output Connector

eSATA (External Serial ATA) for connection of an external storage device capable of transferring data at very high speed

POWER CONTROL IN receives turn-on signals from a McIntosh component and POWER CONTROL OUT sends turn-on signals on to another McIntosh Component

BALANCED AUDIO OUTPUTS supply analog audio signals to connect to Balanced Inputs of other components

DVI (Digital Video Interface) Output for connecting to a HDTV or Monitor with a DVI Input Connector with a video resolution 720p or 1080p

USB (version 2) for connection of an external storage device capable of transferring data

COAXIAL and OPTICAL AUDIO OUTPUTS send a Digital Audio Signal to a Preamp or an A/V Control Center with a D/A Converter or a decoder

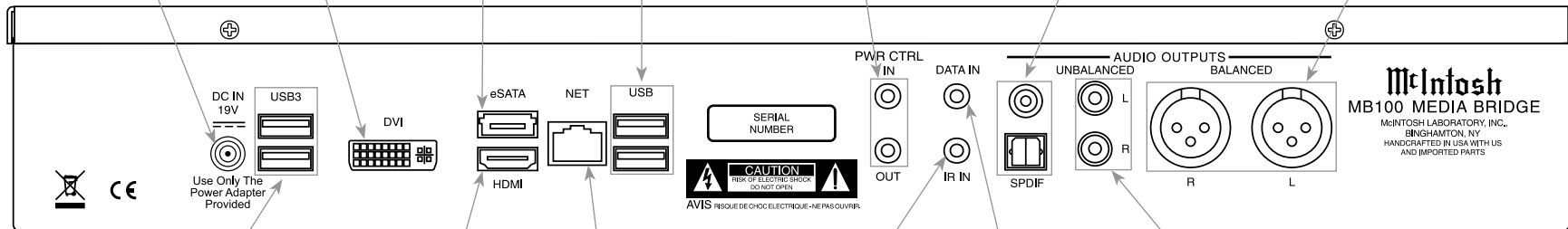

USB 3 (version 3) for connection of an external storage device capable of transferring data at high speed

HDMI (High-Definition Multimedia Interface) Output (Audio and Video Digital Signals) for connecting to a HDTV or Monitor with a HDMI Input with a video resolution 720p or 1080p

NETWORK Connector for connecting the MB100 to a Broadband Ethernet Network

IR IN for connecting an IR Receiver

DATA IN receives control data from a McIntosh Control Center

UNBALANCED AUDIO OUTPUTS supply analog audio signals to Unbalanced Inputs of other components



MB100 Connections

The MB100 has the ability to be remotely switched On/Off from a McIntosh Preamplifier or A/V Control Center via the Power Control connection. The MB100 Data Port Connection allows for the remote operation of basic functions using the Preamplifier or A/V Control Center Remote Control. With an external sensor connected to the MB100, remote control operation is possible from another room and/or when the MB100 is located in a cabinet with the doors closed.

The connection instructions below together with the MB100 Connection Diagram on the next page is an example of a typical audio or audio/video system. Your system may vary from this, however the actual components would be connected in a similar manner. For additional information refer to “Connector and Cable Information” on page 4.

Power Control Connections:

1. Connect a Control Cable from the Preamplifier or A/V Control Center Power Control MAIN (or ACC) Jack to the PWR CTRL (Power Control) IN Jack on the McIntosh MB100 Media Bridge.
2. Optionally, connect a Control Cable from the MB100 Media Bridge PWR CTRL OUT Jack to another component.
3. Connect any additional components in a similar manner, as outlined in steps 1 thru 3.

Data Control Connections:

5. Connect a Control Cable from the Preamplifier or A/V Control Center SRVR Data Port Jack to the McIntosh MB100 Media Bridge DATA IN Jack.

Sensor Connections:

6. Optionally, connect an IR Sensor to the McIntosh MB100 Media Bridge IR IN Jack.

Digital Audio Connections:

7. Optionally, connect a Cable from the McIntosh MB100 Media Bridge AUDIO OUTPUT SPDIF Optical output to the DIG 1 Input on the Preamplifier or A/V Control Center.

Note: Coaxial connections may be used instead of the Optical Connections.

Analog Audio Connections:

8. Connect a Cable from the McIntosh MB100 Media Bridge AUDIO OUTPUT, UNBALANCED Jacks to the Preamplifier or A/V Control Center SRVR Input Jacks.

Note: Balanced connections may be used instead of the Unbalanced Connections.

Digital Video Connections:

9. Connect a HDMI Cable between the HDMI Socket on the Rear Panel of the MB100 Media Bridge to a HDMI Input Socket on the HD Monitor/TV.

Note: If the HD/Monitor/TV has a DVI Input instead of a HDMI input, then connect a DVI cable between the MB100 and the HD/Monitor/TV.

Network Connections:

10. Using a CAT 5/6 Ethernet Cable, connect the cable from the Router to the NET (Network) connector on the Rear Panel of the MB100.
11. Optionally, Connect another CAT 5/6 Ethernet Cable from the Computer (Network Connector) to the Router.

Note: For additional information on Networks and Network Connections refer to the documentation supplied with the Router and Computer.

AC Power Cords Connections:

12. Locate the plug at the end of the cable coming out of the supplied AC/DC Power Supply and connect it to the DC Input connector on the Rear Panel of the MB100 Media Bridge.
13. Connect the supplied AC Power Cord between the socket on the AC/DC Power Supply and a live AC outlet (that is always On).

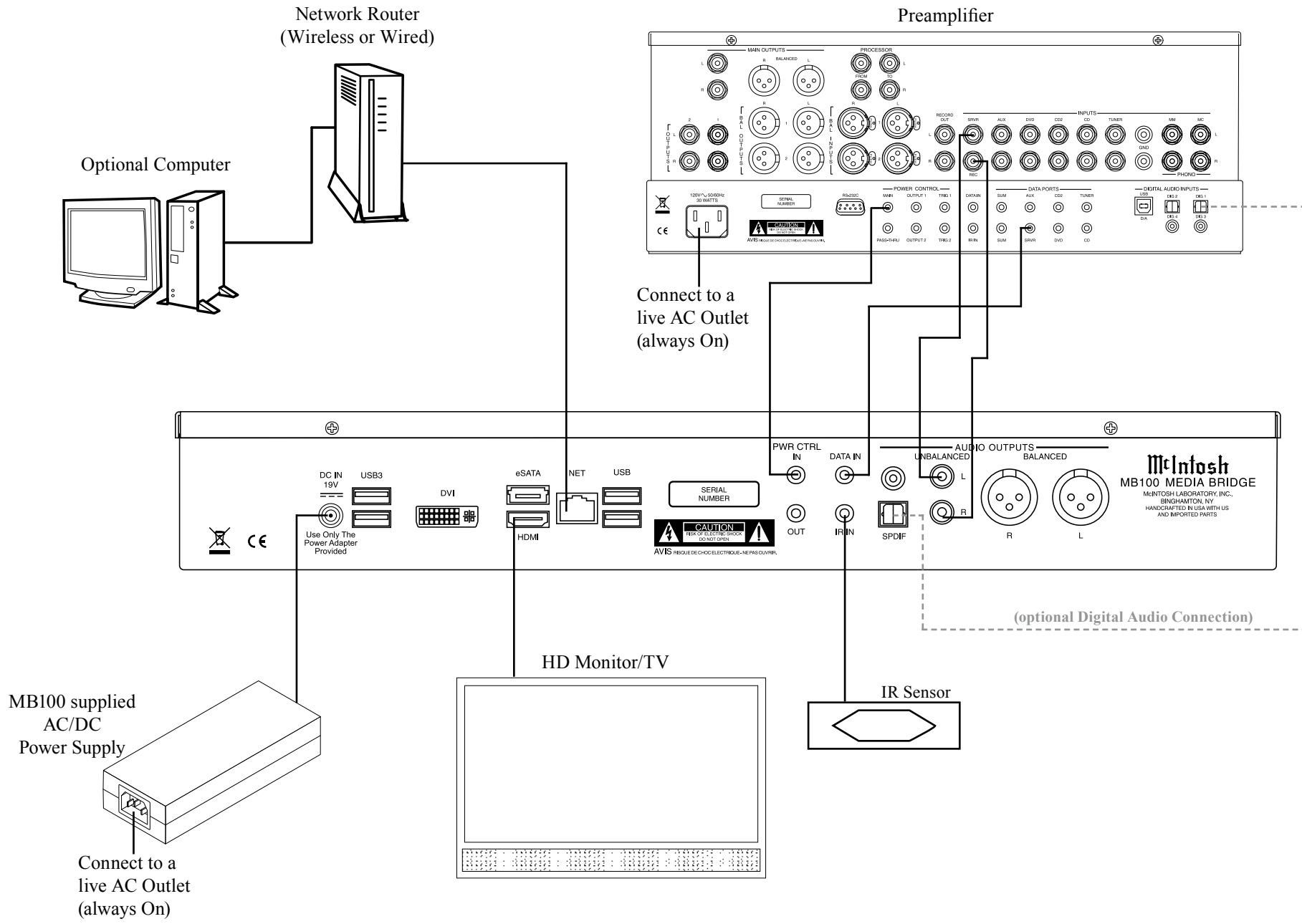

Front Panel Display indicates various operation functions

IR Sensor receives commands from a Remote Control



STANDBY/ON Push-button with indicator switches the MB100 ON or OFF (Standby) and resets the microprocessors

How to use the Remote Control

The Remote Control is capable of performing most Operating Functions for the MB100 Media Bridge.

Note: Refer to the "How to Operate" Section of this manual for additional information using this Remote Control.

Dual Function Push-buttons

The five push-buttons located at the top/front of the Remote Control, in the circular molded area are dual function. When music is playing, the (+) Push-button increases the volume level¹ and the (-) Push-button decreases the volume level¹. Push the ►► Push-button for the next selection or push the ◀◀ Push-button for the previous selection.

During the time a MB100 Menu is being accessed, the push-buttons at the front/top of the Remote Control provide the ability to navigate the menus and select the desired choice or function. The (+) Push-button is used to move the cursor Up through the menu. Likewise, the (-) Push-button is used to move Down, the ◀◀ Push-button is used to move to the left and the ►► is used to select the highlighted choice.

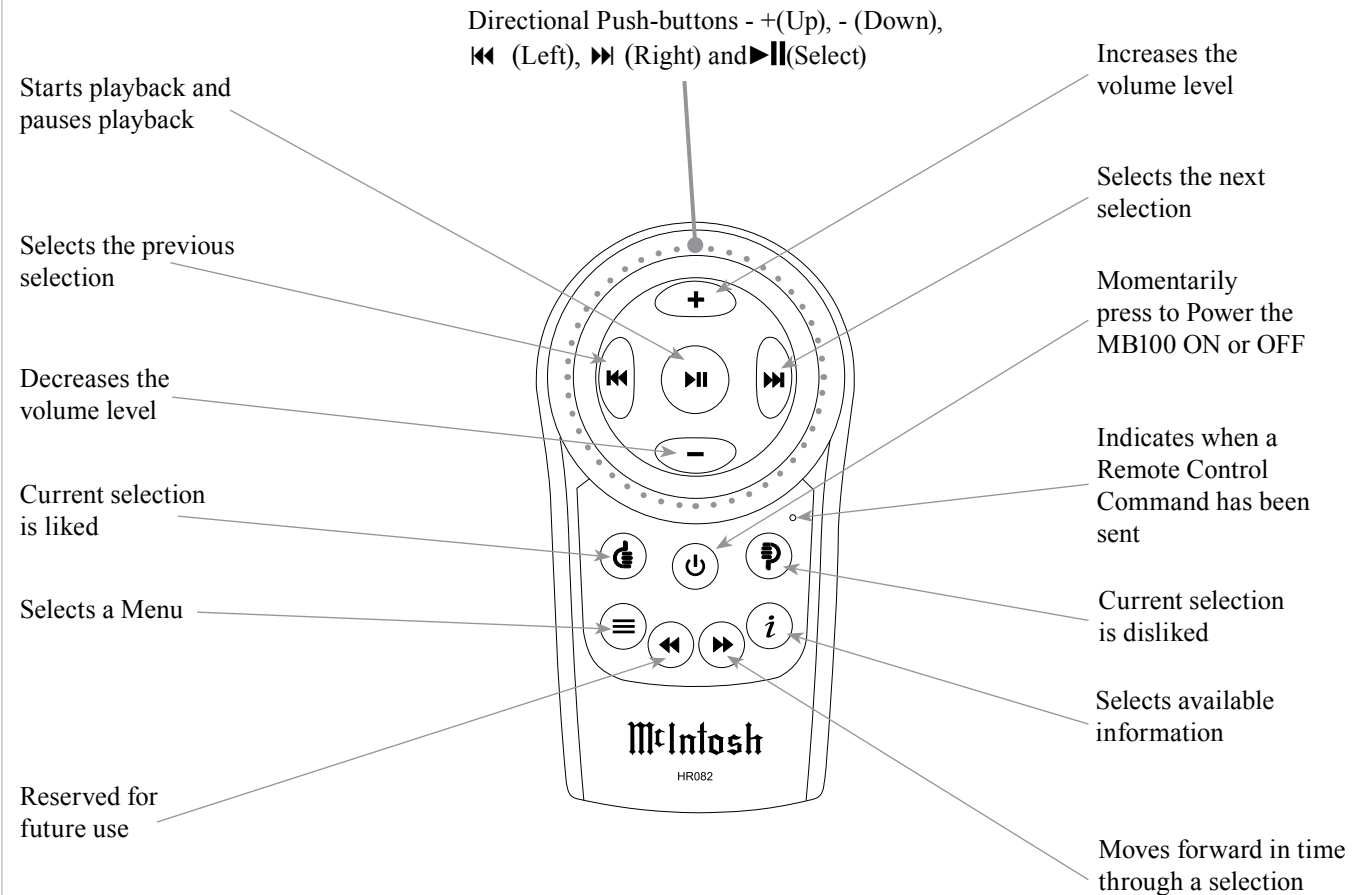

¹Adjusting the volume level using the Remote Control first requires a change to the default setting located in the Setup Mode, refer to pages 16 and 17 for additional information.



How to Operate the Setup Mode

Your McIntosh MB100 has been factory configured for default operating settings that will allow immediate enjoyment of superb audio without the need for further adjustments. If you wish to make changes to the factory default settings, a Setup Feature is provided to customize the operating settings using a PC Computer (not supplied) and the MB100 connected to a HD Monitor/TV. Refer to the MB100 Remote Control Illustration and Operation on page 13, while performing an introduction into operating the Setup Mode, follow the steps below.

1. Press the STANDBY/ON Push-button on the Front Panel or press the  (Power) Push-button on the Remote Control to switch On the MB100. The LED above the STANDBY/ON Push-button will illuminate. The MB100 will go through a startup initialization of which might take upwards of 1.5 minutes with the MB100 Front Panel Display and the connected HD Monitor/TV indicating the progress. Refer to figures 1 thru 5.



Figure 1



Figure 2



Figure 3



Figure 4



Figure 5

2. When the initialization has completed, the operational screen will appear and in the upper left corner is the “Server IP Address: __. __. __. __”. Write down the IP Address Number, as it will be used in the next step. Refer to figure 6.

Note: If the “Server IP Address” number appears as 0.0.0.0, the MB100 was unable to obtain an IP Address from the computer network. Power down the MB100, wait several minutes and then Switch it back On. If the MB100 is still unable to obtain an IP Address, the default automatic configuration setting (DHCP, Dynamic Host Configuration Protocol) might have to be set manually. Contact your Computer Dealer and/or the manufacture of the computer/network hardware for assistance.



Figure 6

3. Using a computer connected to the same network as the MB100, launch an Internet Web Browser Application (such as Windows Internet Explorer). Type in, on the “URL-Address line”, the following:

The IP Address Number written down in step 2

↓
HTTP://__ . __ . __ . __ /config

Then press enter on the computer keyboard. Refer to figure 8. There are selection tabs located across the top of the window (Server Settings, Display Settings, Source Settings, Contents, Source Settings and Firmware). Each of the tabs have subheadings with current status information along with various setup options. There are explanations located to the right of the various options and settings.

4. Click on the “Firmware” Tab (located on the top right side). The current running firmware version is displayed. When a firmware update is available, click on the “Release Notes” button. A new window will appear containing addition information about the update and how to proceed.
5. To exit out of the setup mode, first save any changes made by clicking on the “Save Changes” button and then close down the Internet Web Browser Application.
6. Proceed to “How to Operate” starting on page 18, or to switch Off the MB100, press the STANDBY/ON Push-button on the Front Panel or press the  (Power) Push-button on the Remote Control. Refer to figure 7.

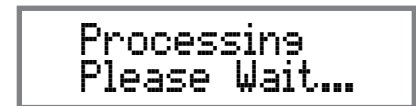

Figure 7

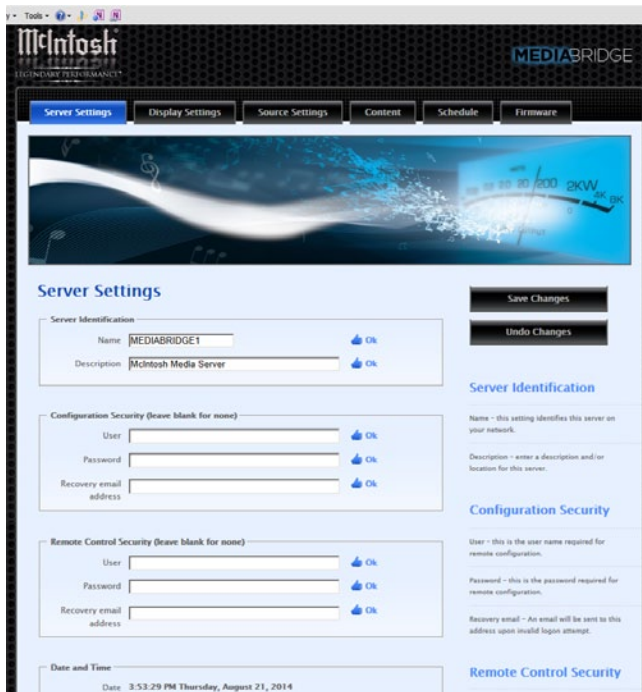

Figure 8

Server Settings

Server Identification:

Name
Description

Configuration Security:

User
Password
Recovery email address

Remote Control Security:

User
Password
Recovery email address

Date and Time:

Time Zone
NTP Server

Wired Ethernet:

Connection

Storage:

82.47% available of 931.51 GB total

Logging:

Your email
Comments

Utilities:

Restart your server

Display Settings

Screen Resolution:

720p - 1280x720
1080p - 1920x1080

On screen display:

Source

Screen Saver:

Enabled
Timeout (seconds)

Slide Show:

Effect in
Effect out

Display Order:

Picture duration:

Scale:

Show Now Playing:

Show song overlay:

Source Settings

Server Audio Outputs:

Name
Form factor
Gain
Format

Control System:

AirPlay:

Password

Contents

Album Art:

Media Synchronization:

McIntosh Media Sync for Windows
(Install Software Application on PC Computer)
McIntosh Media Sync for MAC OS
(Install Software Application on Apple Computer)
Computers

Storage:

Volumes (External USB or E-Sata Drives)
Name (Built in storage total size and free)

Network Content:

NAS Synchronization

Network Content:

NAS Synchronization

Online Credentials:

Amazon Cloud Drive
iTunes
MP3tunes
Pandora Internet Radio
Rhapsody
SiriusXM Internet Radio
Slacker Radio
Spotify
TuneIn Radio
Additional TuneIn Radio Stations

Source Settings

Media Schedule:

Name, Status, Triggers, Next Start Time, Last Start Time and Action

Firmware

Firmware Update:

You are running firmware _._._._._ Release

Other software:

Media Bridge Client

License:

Media Bridge Client

Support:

Remote Support

How to Operate the MB100

Power On and Off

Your McIntosh MB100 has been factory configured for default operating settings that will allow immediate enjoyment of superb audio without the need for further adjustments. Refer to the MB100 Remote Control Illustration and Operation on pages 14 and 15, while performing an introduction into operating the Setup Mode, follow the steps below.

1. Press the STANDBY/ON Push-button on the Front Panel or press the (Power) Push-button on the Remote Control to switch On the MB100. The LED above the STANDBY/ON Push-button will illuminate. The MB100 will go through a startup initialization which might take upwards of 1.5 minutes with the MB100 Front Panel Display and the connected HD Monitor/TV indicating the progress. Refer to figures 20 thru 29.

STANDBY/ON

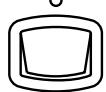

Figure 20



Figure 23



Figure 24

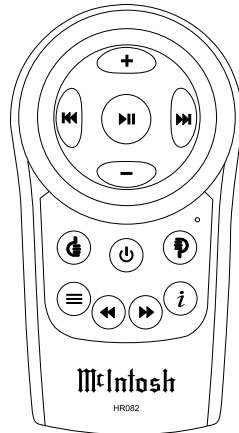

Figure 21

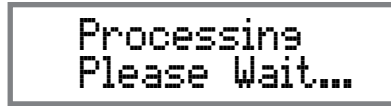

Figure 25



Figure 26



Figure 27

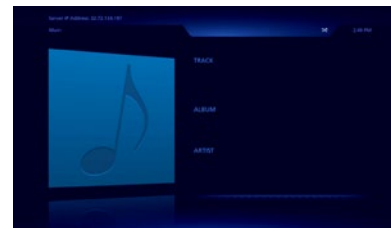

Figure 28

2. To switch Off the MB100, press the STANDBY/ON Push-button on the Front Panel or press the (Power) Push-button on the Remote Control. Refer to figures 21 and 22.



Figure 29



Figure 22

How to Playback Music

Music was imported into the MB100 Media Bridge, at the factory, for your enjoyment. To start listening to the music, perform the following:

1. Press the (MENU) Push-button on the Remote Control to select the operation Menu. Then using the (Down) Push-button on the Remote Control, select the Music Menu followed by pressing the (ENTER) Push-button. Refer to figures 21, 30 and 31.

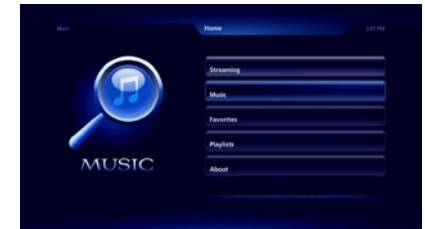

Figure 30



Figure 31

2. Press the (ENTER) Push-button on the Remote Control to view the available Albums. Refer to figure 32.



Figure 32

- Use the + (Up ▲) or - (Down ▼) Push-button on the Remote Control to select the desired album. In this instance, select “Various Artists - Beethoven: Symphonies. Then press the ►|| (ENTER) Push-button to select the album. Refer to figure 33.



Figure 33

- Referring to figure 34, the track for the album just selected will appear. In this instance there is one track “Symphony No. 9 (Scherzo). Refer to figure 34. Press the ►|| (ENTER) Push-button on the Remote Control to start playback of the first track. Refer to figure 35.



Figure 34



Figure 35

The MB100 Front Panel Display will also indicate the current selection. Refer to figure 36.



Figure 36

The TV/Monitor will start to display various scenes while the music is playing. Refer to figures 37 and 38.

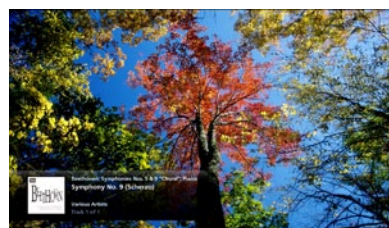

Figure 37



Figure 38

- To pause playback of the music, press the ►|| (ENTER) Push-button on the Remote Control. To resume playback, just press the same Push-button again. To see the status of the track currently playing, press the ⊕ (MENU) Push-button and refer to information located at the bottom of the screen. Refer to figure 34 and 35.

How to Stream Music

The MB100 Media Bridge provides access to virtually unlimited music by streaming music from the Internet. To start streaming music from the Internet, perform the following:

- Press the ⊕ (MENU) Push-button on the Remote Control to select the Home Menu. Refer to figure 40.



Figure 40

- Press the ►|| (ENTER) Push-button on the Remote Control to select the Streaming Menu. Refer to figure 41.



Figure 41

There are many pre-setup Internet Radio Sites to choose from, including Pandora, SiriusXM, Slacker, etc. Some Internet Radio Sites require registering and in some instances a subscription fee in order to enjoy their music services. Using the MB100 Setup Mode on pages 16 and 17, refer to the Contents tab and then the Online Credentials for additional information. In the

How to Operate the MB100, con't

following example, TuneIn Radio will be selected to stream music from local FM/AM radio stations.

- Using the + (Up ▲) or - (Down ▼) Push-button on the Remote Control, select TuneIn Radio from the menu. Refer to figure 42.



Figure 42

- Referring to figure 43, press the ►|| (ENTER) Push-button to select Local Radio.



Figure 43

- There are now menu choices AM, FM or Internet only radio stations. Referring to figure 44, use the + (Up ▲) or - (Down ▼) Push-button to select FM, followed by pressing the ►|| (ENTER) Push-button. Refer to figure 45.



Figure 44

- Following the same procedure as in step 5, select the second choice, "89.3 WSKG-FM (classical)".



Figure 45

The sound from the station will start, figures 46 and 47 will appear in sequence on the TV/Monitor. The MB100 Front Panel Display will indicate "WSKG-FM 89.3, Classical". Refer to figure 48.



Figure 46



Figure 47



Figure 48

How to Operate the MB100 via a Computer

After the MB100 has powered up and completed initialization, note the IP Address assigned to the Media Bridge in the upper left corner. Refer to figure 60.



Figure 60

- Using a computer connected to the same network as the MB100, launch an Internet Web Browser Application (such as Windows Internet Explorer). Type in on the "URL-Address line" the following:

The IP Address Number

HTTP:// _____ /MediaBridge

- A connection progress indicator will appear in the Web Browser. Refer to figure 61.



Figure 61

- When the connecting process is completed, the Media Bridge interface will appear in the Web Browser. Refer to figure 62.

The operation of the MB100 using the Web Browser is similar to using the MB100 connected a monitor/TV along with the supplied Remote Control. The major difference is the computer pointing device (mouse) is used for selection and navigating.



Figure 62

On the left side is a column of buttons for selecting music sources (Streaming, Local Music, Favorites, Playlists and Queue) along with Back and Next control commands. Along the bottom are buttons for standard control functions such as Previous, Play, Pause, Next, Shuffle and Replay.

How to Playback Music

McIntosh Music was imported into the MB100, at the factory, for your enjoyment. To start listening to the music, perform the following:

1. Click on the Local Music button. Refer to figure 62.
2. Click on “Albums”, then select “Beethoven”. Refer to figure 63.



Figure 63

3. Click on the track listing of “1 Symphony No. 9 (Scherzo) 1:15” and click on “Play now”. Refer to figures 63 and 64.



Figure 64

4. Return to the previous menu selection of “Play now, Play next, Replace queue, Add to queue or Add to playlist” by clicking on the Track (Name) currently playing.

How to Stream Music

The MB100 Media Bridge provides access to virtually unlimited music by streaming music from the Internet. To start streaming music from the Internet, perform the following:

1. Click on the Streaming button and the Radio sources menu will appear. Refer to figure 65.



Figure 65

In the following example TuneIn Radio will be selected to stream music from local FM/AM radio stations.

2. Select and click on TuneIn Radio. Click on Local

Radio followed by selecting FM. Refer to figures 66 and 67.



Figure 66



Figure 67

3. Referring to figure 68, select the second choice, “89.3 WSKG-FM (classical)”. The sound from the station will start and figure 69 will appear.



Figure 68



Figure 69

How to Operate the MB100, con't

How to Import Music from External Drives

Before proceeding with the steps below, switch power Off to the MB100. Then connect the External Drive (HDD or SDD) to an USB or eSata connector on the Rear Panel of the MB100. After the MB100 has powered up and completed initialization, note the IP Address in the upper left corner.

- Using a computer connected to the same network as the MB100, launch an Internet Web Browser Application (such as Windows Internet Explorer). Type in on the "URL-Address line" the following:

The IP Address Number

HTTP://_____/config

- Then press enter on the computer keyboard. Refer to figure 80 (partial view).



Figure 80 (partial view)

- Click on the "Content" Tab (located along the top), then scroll down to "Storage". Refer to figure 81.



Figure 81

Referring to figure 82, the "Volumes" window indicates both the MB100 internal storage drive (931.51GB) and an external connected drive (7.35GB).

Volumes				
Connect USB or eSATA drives to expand storage capacity.				
Name	Size	Free		
Built in storage	931.51 GB	931.14 GB		
Volume BCBB035	7.35 GB	7.33 GB	Import	
	931.51 GB	931.14 GB	99.96% free	

Figure 82

- Click on the word "Import" and a window will appear with additional information about the importing process. Refer to figure 83.



Figure 83

Note: The import process will copy all of the music files it finds on the externally connected storage drive. Depending on the amount of music files on the drive, the copying process could take some time.

- Start the import process by clicking on the button "OK, Import the volume". Refer to figures 84 and 85.

Storage				
Volumes				
Connect USB or eSATA drives to expand storage capacity.				
Name	Size	Free		
Built in storage	931.51 GB	931.14 GB		
Volume BCBB035	7.35 GB	7.33 GB	Importing...	
	931.51 GB	931.14 GB	99.96% free	

Figure 84

Storage				
Volumes				
Connect USB or eSATA drives to expand storage capacity.				
Name	Size	Free		
Built in storage	931.51 GB	931.12 GB		
Volume BCBB035	7.35 GB	7.33 GB	Ejecting...	
	931.51 GB	931.12 GB	99.96% free	

Figure 85

- To listen to the music just imported (when the importing process is complete) enter into the "URL-Address line" below:

The IP Address Number

HTTP://_____/MediaBridge

- Then select local music, click on albums, selecting the desired music, followed by selecting either "Play all" or the desired track. Refer to figures 86 and 87



Figure 86



Figure 87





Audio Specifications

Fixed Output Level

2.0Vrms Unbalanced
4.0Vrms Balanced

Output Impedance

600 ohms Unbalanced and Balanced

Signal to Noise Ratio

102dB (IHF A-Weighted)

Dynamic Range

96dB

Harmonic Distortion

0.005%

Channel Separation

95dB (1,000Hz)

Digital Audio Specifications

Digital Output

Coaxial: 0.5V p-p/75 ohms
Optical: - 15dbm to -21dbm (TOS Link)

Digital Output Format

SPDIF (PCM¹)

Digital Output Sample Rate

Up to 24-Bit/192kHz

¹ PCM (Pulse Code Modulation) Digital Signal Type

Video Specifications

Signal System

Digital Video

Signal Format

HDMI and DVI

Screen Resolution

720p or 1080p

Power Control Specifications

Power Control Input

5-15VDC, less than 1mA

Power Control Output

12VDC, 25mA maximum total

General Specifications

Power Requirements

Field AC Voltage conversion of the MB100 is not possible. The MB100 is factory configured for following AC Voltages:
100-240 Volts, 50/60Hz at 2.0 Amps
Standby: Less than 0.5 watt

Overall Dimensions

Width is 17-1/2 inches (44.4cm)
Height is 3-7/8 inches (9.8cm)
Depth is 16 inches (40.6cm) including the Front Panel and connection cables.

Weight

13.5 pounds (6.1Kg) net (includes the external Power Supply), 28 pounds (12.7Kg) in shipping carton

Shipping Carton Dimensions

Width is 26-1/2 inches (67.3cm)
Height is 11-3/4 inches (29.9cm)
Depth is 24-1/4 inches (62.2cm)

Packing Instructions

In the event it is necessary to repack the equipment for shipment, the equipment must be packed exactly as shown below. It is very important that the four plastic feet are attached to the bottom of the equipment. This will ensure the proper equipment location on the bottom pad. Failure to do this will result in shipping damage.

Use the original shipping carton and interior parts only if they are all in good serviceable condition. If a shipping carton or any of the interior part(s) are needed, please call or write Customer Service Department of McIntosh Laboratory. Refer to page 4. Please see the Part List for the correct part numbers.

Quantity	Part Number	Description
1	033838	Shipping carton only
4	033837	End cap
1	033836	Inside carton only
1	033725	Top pad
1	034301	Bottom pad
1	034547	Bottom filler pad
2	034446	Foam plug
4	017937	Plastic foot
4	400159	#10-32 x 3/4" screw
4	404080	#10 Flat washer

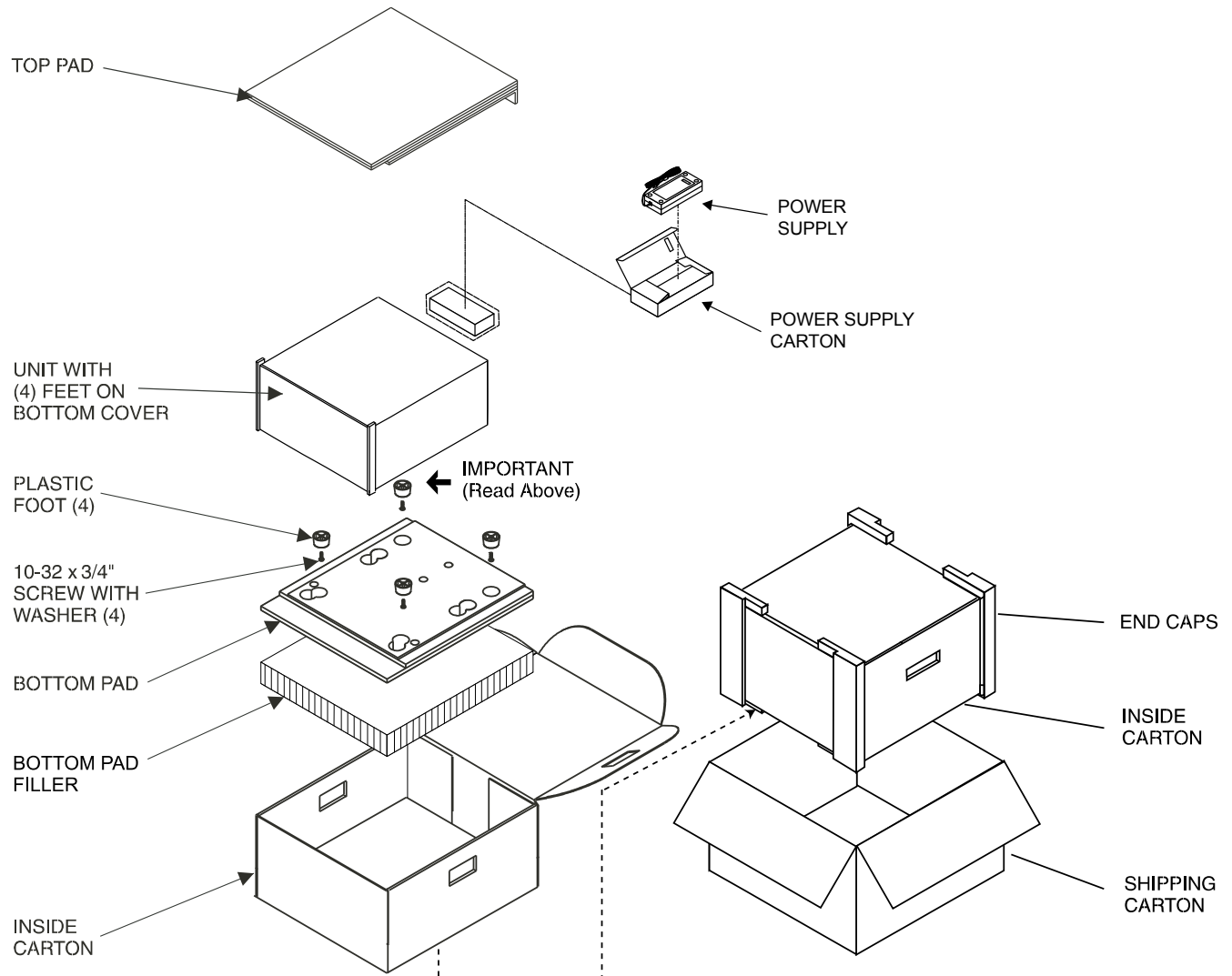



McIntosh Laboratory, Inc.
2 Chambers Street
Binghamton, NY 13903
www.mcintoshlabs.com

The continuous improvement of its products is the policy of McIntosh Laboratory Incorporated who reserve the right to improve design without notice.
Printed in the U.S.A.